

Nonlinear Dynamic Analysis of Pile Foundation Subjected to Strong Ground Motion Using Fiber Elements

B. Asgarian*, M. Zarrin, M. Boroumand

*Civil Engineering Faculty, K.N.Toosi University of Technology, Tehran, Iran; asgarian@kntu.ac.ir.

ARTICLE INFO

Article History:

Received: 25 June 2012

Accepted: 4 February 2013

Available online: 30 June 2013

Keywords:

Nonlinear Dynamic Analysis

Fiber Elements

Jacket Type Offshore Platforms

Seismic Soil-Pile-SuperStructure

Interactions

Centrifuge experiments

ABSTRACT

In this paper, pile behavior embedded in layered soil deposits subjected to seismic loadings is analyzed using a nonlinear fiber element for simulation of soil – pile interactions. In the created model, both pile and surrounding soil are modeled using fiber elements in a practical Beam on Nonlinear Winkler Foundation (BNWF) concept. Herein, the features of DRAIN-3DX finite element software are utilized in order to develop the model. In the presented approach for performing of Seismic Soil-Pile-Superstructure Interaction (SSPSI) analysis, the constitutive behavior of soil and steel pile are assigned to fiber elements using available soil p-y backbone curves and steel stress-strain relationship. The effect of radiation damping is incorporated into the model by adding a dashpot in parallel with nonlinear p-y element. In order to consider the effects of free field site response in different soil layers, EERA and NERA programs are used. Results of the analyses are compared with available experimental data. The results are in good agreement with the available centrifuge test results. The main purpose of the proposed method is to make DRAIN-3DX software capable of performing SSPSI analysis of any pile supported structure especially Jacket Type Offshore Platforms (JTOP).

1. Introduction

The primary structural component of Jacket Type Offshore Platforms (JTOP) include deck, jacket and pile foundations. Pile foundations are an essential structural component of this type of structure, and the Seismic Soil-Pile-Superstructure Interaction (SSPSI) is an important concern in seismic behavior of this kind of structure. Strong ground motions have been a major cause of past damages in pile foundations and reliably evaluating the dynamic response of pile foundations against this type of lateral loading plays paramount important role in pile foundations design practice.

In the analysis of a soil-pile system subjected to strong ground motions, where the soil is highly nonlinear, hence, a time-domain analysis should be performed in order to properly account for both the nonlinear behavior of soil and the complicated coupling interaction between the soil and steel pile [1, 2]. Thus, Providing an efficient and at the same time accurate analytical or numerical analysis procedure for performing lateral time history analysis of the pile supported structures specially JTOPs, becomes essential.

The Drain-3DX [3] software is a general finite-element program for “dynamic response analysis of

inelastic frame structures” which has the capability of accounting for geometric and material non-linearity properties. Asgarian et al. [4] formulated and implemented the element “Fiber Beam Column Post Buckling Element” as element type E16 in this software, which is capable of simulating buckling behavior, post buckling behavior and distributed inelasticity of both strut and portal steel tubular members. Asgarian et al. [5] verified Fiber Beam Column Post Buckling Element behavior using experimental data for individual strut and portal members and also using nonlinear behavior of two tested X-braced jackets, made up of tubular members subjected to cyclic lateral displacement. They reported that the results of their analyses with element type 16 agreed fairly well with experimental results, which showed that the implementation of this element was successful in predicting cyclic inelastic behavior of frames of tubular members. Using this element in conjunction with other types of elements such as Elastic Beam-Column Element (El. E17), Fiber Hinge Beam Column Element (El. E08), and Fiber Beam-Column Element (El. E15), the hysteretic response of steel piles and jacket frame of JTOP structures under cyclic and seismic loading can be simulated.

However, for predicting global seismic response of real JTPOs, additional considerations are needed for modeling of pile-soil interaction mechanism. Drain-3DX has no direct provisions for nonlinear p-y elements, which are commonly used to simulate nonlinear near field soil response. Thus, equivalent methods should be introduced to substitute the soil layers with equivalent elements having the identical pile-soil interface characteristics. Asgarian and Lesani [6] were used equivalent methods in pushover analysis of two functional jacket offshore platforms in the Persian Gulf using Fiber Beam Column Post Buckling element for modeling both braces and soil-pile-structure interaction. In their model, available p-y curve characteristics were assigned to stress-strain constitutive behavior of fibers of horizontal supporting soil elements. In the current study, the same procedures as those reported in Asgarian and Lesani [6] is extended to be applied to dynamic loading with some modifications to account for radiation damping and opening of gaps. As a conclusion, if simulation capability of Drain-3DX software in modeling SSPSI problems and also the method of this problem modeling are evaluated, together with other material and element database of Drain-3DX, the whole JTPOs dynamic analysis subjected to earthquake loadings can be predicted reliably by this software.

In this paper, a nonlinear fiber element is used for modeling of soil-pile-structure system and their interaction during earthquakes. To this manner, a numerical model which is capable of handling both nonlinear steel pile, and nonlinear soil support behavior is developed using Fiber Beam Column Element (Type 15) of DRAIN-3DX software [3]. The model is applied to perform a series of dynamic centrifuge tests of a pile supported superstructures, and the analysis results are compared with the available test results. Sensitivity of the analysis results to pile equivalent viscous damping, and site response calculation methods is evaluated by numerical parameter studies. It should be noted that the numerical model presented in this study was previously introduced by authors in [7]. In current paper, the numerical model is demonstrated in more detail with some discussions on various advantages and shortcomings of the proposed model. Furthermore, the model is verified herein with more events of centrifuge experiment and is extended to case of pile foundations driven in cohesive soils.

2. Soil - Pile - Structure Interaction

Various numerical and experimental methods with varying complexity and efficiency have been used in the past for the seismic response analysis of pile foundations. The level of complexity needs to be considered depends on the purpose, importance and type of structure, type of loading during design life,

severity of loading and as a result level of nonlinearity in materials. In general, there are two main numerical methods for predicting response of pile foundations. The first method is a continuum based method, and the second one is discrete element method that models the soil through a set of independent springs [8]. Finite difference, boundary element and finite-element methods are categorized as the continuum based methods and Beam on Nonlinear Winkler Foundations (BNWF) is categorized as a discrete element method [9, 10].

Although the continuum approaches have no limitation in solving different issues of SSPSI problems such as soil and pile nonlinearities, contact mechanism, various loading cases and different geometries, however, the high computational demands along with inherent complexity that they require make them less attractive to be used in common design practices. On the other hand, discrete element method is a simplified and efficient approach which is considerably less complex than the continuum based methods.

The most accepted discrete element method is the p-y method. By ignoring the shear transfer between adjacent layers and accepting Winkler's foundation assumption (1876) in which each layer of soil responds independently to surrounding layers, an approach named p-y method arose, which is used throughout this paper. In this method, the pile is modeled as beam elements while the surrounding soil is modeled using continuously springs and dashpots. The dashpots placed in series or parallel with the nonlinear springs account for energy loss due to radiation damping under dynamic loading conditions. The force displacement behavior of springs has been back calculated from the results of well instrumented pile lateral load tests in different soil conditions. Matlock [11] conducted some static and dynamic in situ tests and derived p-y curves for soft clays, which have been codified in API recommended practice [2]. In 1983, O'neil and Murchison [12] compared the accuracy of the hyperbolic tangent curve for sandy soils by works of other researchers and found it as the best relation for this type of soil. Bea [13] presented guidelines for formulating t-z and q-z curves with taking into account strain rate effects and cyclic degradation. Similarly, different p-y curves have been formulated during last years of research. In the original BNWF method, the pile was assumed to behave linearly. However, Pile nonlinearity may be considered in the analysis using an appropriate material model. The considerable shortcoming of BNWF method is the two-dimensional simplification of analysis with no additional efforts made for carefully modeling radial and the slipping mechanism between pile and soil. However, BNWF method is a versatile and economic method that can account for

various complicated conditions in a simplified manner which makes it attractive to engineers.

When a pile is subjected to ground motion, the behavior and response of soil in the vicinity of pile and the part of soil that is far from the pile are different. Thus, the soil is divided into two regions. The region closest to the pile is an inner zone which is adjacent to the pile and accounts for the soil nonlinearity. The other region is the outer zone that allows for wave propagation away from the pile and provides for the radiation damping in the soil medium [10]. The inner zone is the near field, and the outer zone is the far field. Any implementation of BNWF model should provide some features for simulating the response of these two zones precisely.

For the structures founded on piles, which are embedded into the soil, the seismic excitation that piles experience differs from that of the reference rock motion beneath the soil. In general, this deviation originates from the following effects [14]: the first modification known as the free field site response is made when vertical s-waves propagate upward through soil layers and reach to the free surface, assuming that the foundation is absent. In most cases, the amplitude of horizontal displacements increases gradually towards the surface. The amount of this increase depends on frequency content of motion and also how much the soil shows the non-linear response as a consequence of severity of excitation. The second reason of deviation is the result of the so-called kinematic interaction part of response, which is due to differences between pile-soil stiffness relative to soil only and also diffraction of the incident and reflected one-dimensional vertical s-waves off the pile. The third and final source of deviation between rock out crop motion and the motion that foundation experiences, is called inertial interaction. After the computation of kinematic interaction part, the

resultant motion is used as foundation input motion (FIM) for computing the complete response of a soil – pile -structure system which in turn applies some inertial loads on the system, leading to an overturning moment and a transverse shear acting on the pile head. It is possible to analyze the kinematic interaction and inertial interaction stages in one single step using Beam on Nonlinear Winkler Foundation method. Thus in this procedure we uncouple the problem into analysis of 1) free field site response as an input to the analysis 2) The response analysis of pile foundation subjected to accelerations at different soil layers due to seismic excitation in bedrock. Figure 1 shows the steps performed in this paper for the nonlinear dynamic analysis of pile foundation subjected to strong ground motions. In the current work, the response of the free field soil profile is analyzed using (EERA) and (NERA) software packages [15, 16]. In this study, fiber element is used for modeling the nonlinearity and damping characteristics of near field soil as well as the pile member. In this method, p-y, t-z and q-z springs of the soil are used to model soil-pile interaction. The t-z materials are incorporated into the model to apply skin friction on the pile. A q-z element is also installed under the pile to account for end bearing reaction. When all the t-z elements along the pile and q-z element yield to their ultimate strength, the pile starts to move in vertical direction and no more vertical resistance remains for the pile. This can be interpreted as “Pull-Out” in the pile. However, after occurrence of pull-out in the numerical model in this paper, the pile faces overall stability problem and consequently, the numerical model fails to converge. On the contrary, in the case of a JTOP numerical model, when one of the piles starts to pull-out, the model retains its stability due to existence of other piles of JTOP.

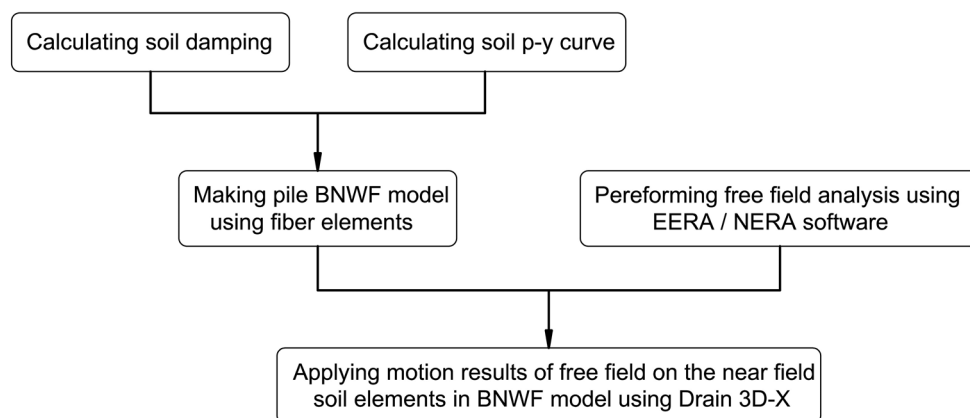

Figure 1. Steps for the nonlinear dynamic analysis of pile foundation subjected to strong ground motions

3. Free-Field Site Response Analysis

The first step in any uncoupled SSPSI analysis is computation of soil profile horizontal response as a function of depth to vertically propagating shear waves. Because of the differences between the polarity of S waves in the free field (τ_{xz} and τ_{yz} shear stress waves) and the polarity of τ_{xy} stress waves and p waves that are radiated from a pile, dividing of SSPSI analysis into two steps would be expected to be a rational approximation [17]. Regularly, this step of analysis is performed using common site response programs. In this paper, free field soil responses are computed using EERA and NERA packages developed by Bardet (2000), (2001) [15],[16]. In these packages, ground motions in soil layers are calculated due to earthquake excitations at bedrock. In EERA (Equivalent-linear Earthquake site Response Analyses of Layered Soil Deposits), nonlinear stress-strain response of soil layers is approximated by an equivalent linear approach using a modified Kelvin-Voigt model [15]. In this method, nonlinear and hysteretic stress strain behavior of soil is approximated by an equivalent linear shear modulus, G , taken as the secant shear modulus G_s defined as follows:

$$G_s = \frac{\tau_c}{\gamma_c} \quad (1)$$

In which τ_c and γ_c are the maximum stress and strain amplitudes respectively [15]. NERA (Nonlinear Earthquake site Response Analysis of layered soil deposits) is based on a nonlinear soil stress-strain curves using a series of mechanical elements, having different stiffness K_i and sliding resistance R_i [18], [19]. These sliders have increasing resistance. Initially the residual stresses in all sliders are equal to zero. In the stress-strain curve generated by the Iwan-Mroz model the stress increment $d\tau$ and strain increment $d\gamma$ are related through the following equation [16].

$$\frac{d\tau}{d\gamma} = H \quad (2)$$

4. Soil Stiffness and Damping Properties

In this study, the soil stiffness is established using the p-y approach. The procedures of generating p-y curves are proposed by Matlock [11], Reese et al. [8], and O'neil and Murchison [12] and are recommended in American Petroleum Institute code (API-RP-2A) [2]. In the present paper, the constitutive behavior of equivalent soil material for clay was based upon Matlock's relations for soft clay for static loading condition. Since the Matlock's cyclic loading modifications were calibrated for a large number of wind and wave loading cycles in sensitive clay soils,

it's irrational and inaccurate to use them for seismic loading condition. Herein, API's recommended p-y backbone relation for drained sand is used for calculation of cohesionless soil p-y curve.

Another aspect of SSPSI analysis is that every implementation of p-y method is expected to include radiation damping. The radiation of energy of the propagating waves from foundation leads to additional damping in the dynamic response of the system. This type of damping provides a major source of energy dissipation in soil-pile systems subjected to dynamic loading. Herein, the dashpot coefficient is determined based on the recommendation of Wang et al. [17], which is a modification of work done by Berger [9]. According to this recommendation, the radiation damping coefficient is calculated by the following relation:

$$C = 4\rho BV_s \quad (3)$$

Where C is the damping coefficient, ρ is the density of soil, and V_s is the shear wave velocity of soil. In this paper, damping component of soil resistance is represented by a dashpot parallel to the nonlinear spring element.

5. Model Description

A beam on nonlinear Winkler's foundation numerical model is created in the finite-element program Drain-3DX in order to perform uncoupled seismic SSPSI analysis. In the numerical model proposed in this paper, the pile-soil system is modeled through equivalent elements. The Fiber Beam Column Element (Type 15) and (Type 16) of DRAIN-3DX are used for the linear and nonlinear modeling of surrounding soil and pile, respectively. Figure 2 shows Fiber Beam Column Element general configuration. In this element, the member is divided into a number of segments without introducing additional degrees of freedom. The cross-section of the segment is then subdivided into a number of fibers. This element is a flexibility based element, and its shape function varies as the state of the element changes, without introducing additional nodes or elements [3], [20].

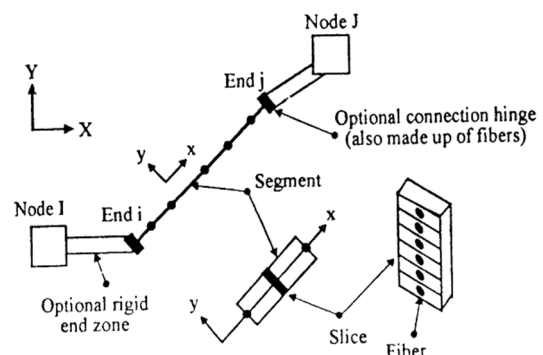

Figure 2. Element type 15 configuration [3], [20]

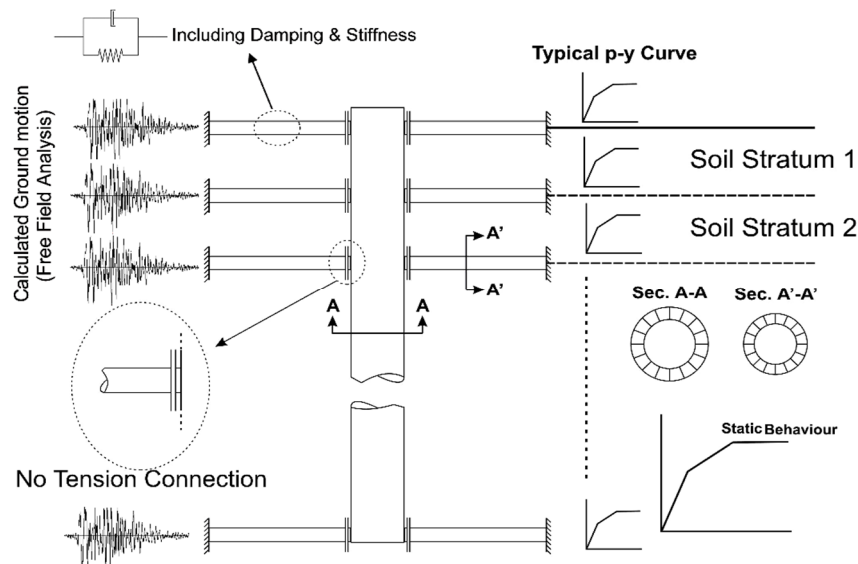

Figure 3. View of BNWF model for nonlinear dynamic response analysis of jacket pile using Fiber Elements

The specific stress strain curve should be defined for each of the fibers. Two types of behavior (Concrete type or steel type) are used for the fiber Stress-Strain Curve. Concrete type is used to simulate the displacement softening phenomena and steel type material library is used to simulate the displacement hardening phenomena.

Figure 3 shows the configuration of the proposed model. In this figure, the vertical member represents the steel pile which is a real component. The pile is discretized into a number of elements. Fiber Beam Column Post Buckling Element (EL. E16) is used for modeling of the pile. Each of the pile elements are divided into a number of segments. Then, the cross-section of the pile segments is subdivided into a number of fibers. Using a bilinear Stress-Strain curve for the fibers, elastic-plastic behavior of pile cross section can be simulated. Furthermore, utilizing a non-zero positive stiffness for post yield part of bilinear Stress-Strain curve, the strain hardening effects can be modeled.

The strain hardening property of the created model, enable it to continue its response beyond full hinge formation (the state of all fibers yielding in a cross section). The horizontal supporting beams in Figure 3 are added to pile element ends to represent soil near-field nonlinear behavior and damping. The materials for the supporting beams at each pile nodes are set to have their special Stress-Strain relationship in such a way to simulate the characteristics of p-y response of the layered soils. For modeling the interface between soil and pile, element number 9 of DRAIN-3DX software (which is a compression link element) is used. A compression link element has finite stiffness in compression, and a gap opens in tension. This link element is chosen to filter the undesirable tension between soil and steel pile. It also filters bending moments in soil element. The inclusion of the gap in this link element provides a means to model opened

gap between pile and soil in cyclic behavior of cohesive soils. These members are modeled in such a way that no tension can transfer from soil element to pile element. The radiation damping of soil was implicitly simulated by an equivalent viscous damping dashpot in each element. In this model, the radiation damping is modeled by a dashpot parallel to horizontal beams using damping coefficient recommended by Berger [9].

This feature can represent the radiation damping of the soil. In the analysis, the predicted acceleration time histories at different soil layers computed using EERA-NERA packages are directly used as inputs into the analysis.

6. Simulation Results

In this section, the proposed model is applied to simulate nonlinear seismic behavior of soil pile superstructure system subjected to ground motion. In order to verify the developed computer model, a comparison is made with available experimental centrifuge tests performed by Wilson et al. [21] using the large servo-hydraulic shaking table at the university of California at Davis. A wide variety of experiments on dynamic behavior of single piles and pile groups in different layering forms were carried out and documented in Wilson et al. [21]. The flexible shear beam (FSB) container used for these tests has inside dimensions of 1.72 m long, 0.685 m wide and 0.7 m deep. FSB consists of six hollow aluminum rings separated by 12 mm thick layers of soft rubber allowing the container to deform with the soil. The mass of each of the upper three rings is about one-half the mass of each of the lower three rings. All tests were performed at a centrifugal acceleration of 30 g. All dimensions of results presented herein are in prototype unit. The results of the centrifuge tests are available in detail in University of California at Davis website [22]. In this paper, several events of the CSP3

and CSP5 cases of these tests are analyzed, and the results are compared with the experimental ones.

6.1. CSP3 tests

In this case, the soil profile consisted of two horizontal sand layers [23]. The lower layer was fine uniformly graded Nevada sand, 11.1 m thickness with $C_u = 1.5$ and $D_{50} = 15$ mm. The dry density of sand was 16.2 KN/m^3 at a relative density of $D_r = 75\text{-}80\%$. The upper layer was Nevada medium dense sand with 9.3 m thickness, $C_u = 1.5$, $\gamma_d = 15.5 \text{ KN/m}^3$ at relative density of $D_r = 55\%$. In this paper, pile Sp1 has been analyzed, which consists of a super structure mass of 49.1 ton attached to an extension of the pile about 3.81m above ground surface and embedded in soil profile described earlier. The pile material was aluminum and had a diameter of 0.667 m, 63 mm wall thickness with a flexural stiffness of 417 MN.m^2 , which is equivalent to a 0.67 m diameter steel pipe pile with a 19 mm wall thickness. This model was shaken by several simulated earthquakes. Analyzed earthquake events information is presented in table 1. Detailed documentation of the test and recorded time histories are available in Wilson et al. [23]. Calculated and recorded horizontal Acceleration Response Spectra (ARS) at different depths (considering 5% of damping) for CSP3 shaking events are shown in Figures 4, 5 and 6. In these events, calculated Acceleration Response Spectra in all depths are in good agreement with the recorded acceleration

response spectra at corresponding depths. It can be seen that NERA results are closer to the experimental results. Generally, a slight tendency to underestimate the recorded results is observed in calculated responses.

In the BNWF analysis, the material damping coefficient is assumed to vary between 1% and 5%. Therefore, the pile is analyzed with both 1% and 5% material damping. Response of the superstructure for event CSP3-K in comparison with experimental result for 1% material damping is presented in Figure 7. The ARS of this event is plotted in Figure 8. It should be noted that the acceleration response spectra is calculated for a damping factor of 5% using a simple one degree of freedom system. In a similar way, the Responses of the superstructure for CSP3-P and CSP3-M events are compared with the experimental results for both 1% and 5% material damping. It is observed that structural damping has no major effect on dynamic response of pile foundation. These results show reasonably good agreement between the calculated and recorded structural responses of CSP3 for these shaking events. It is observed from superstructure ARS both in experiment and analysis results that the equivalent fundamental period of the structural model varied from 0.8S under event "K" to 1.1S under event "P". This is the consequence of occurrence of nonlinearity in the soil profile, especially in upper soil layer.

Table 1. Earthquake events for CSP3

Event	Motion	Peak Base Acceleration (g)
K	1989 Loma Prieta (Santa Cruz)	0.11
P	1989 Loma Prieta (Santa Cruz)	0.50
M	1989 Loma Prieta (Santa Cruz)*	0.44

*time step of the original recording was doubled for this motion

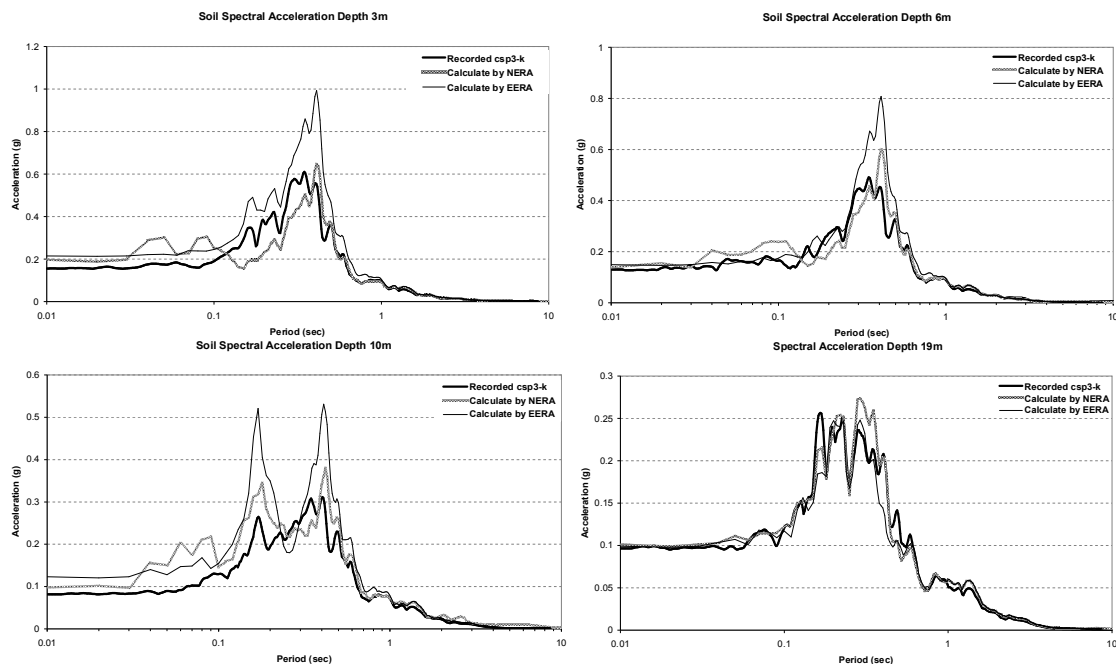

Figure 4. ARS of soil profile in CSP3-k

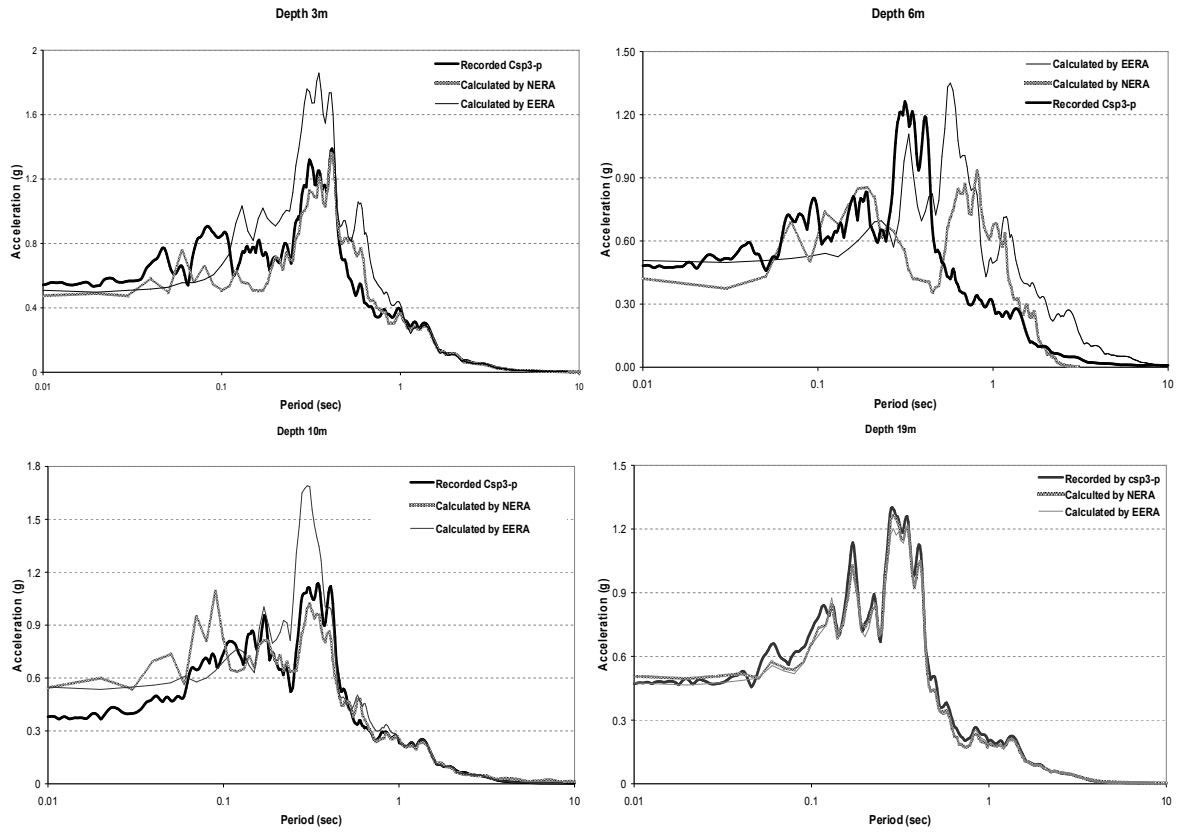

Figure 5. ARS of soil profile in CSP3-P

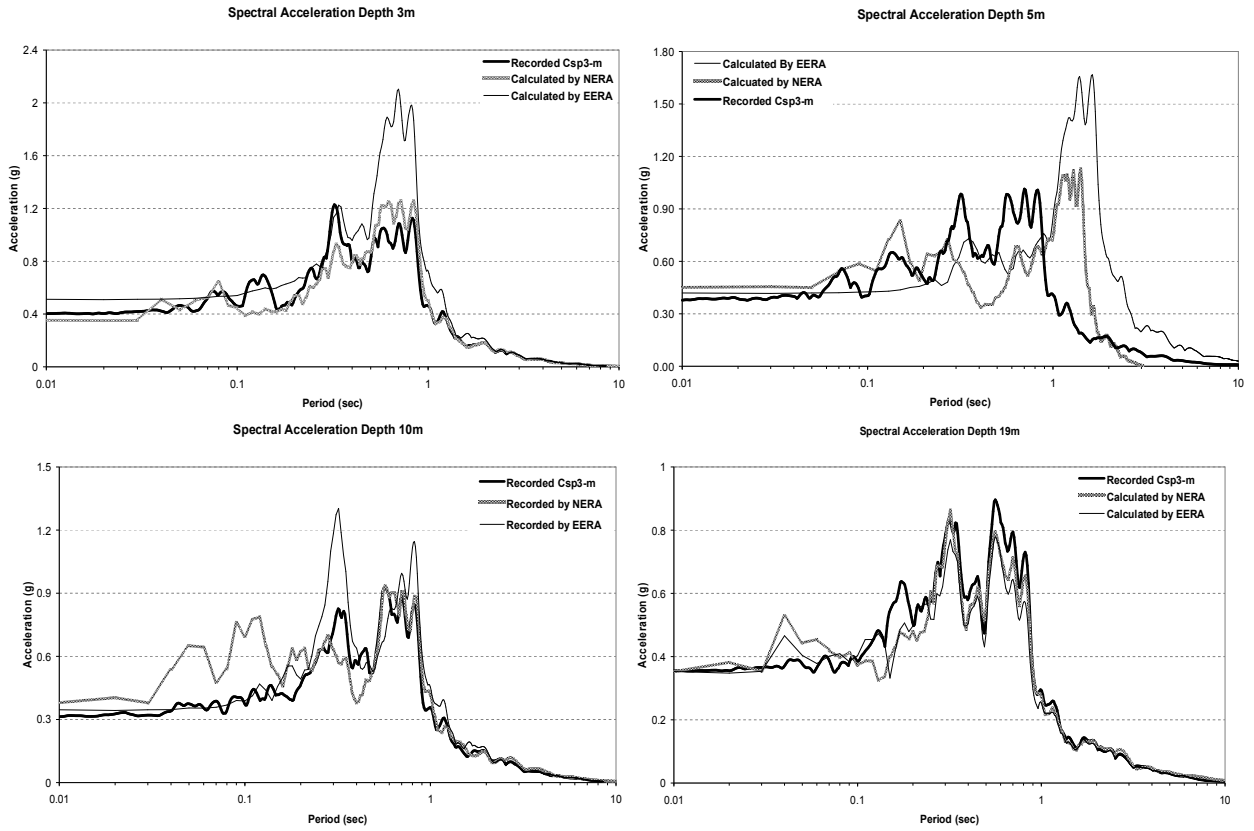

Figure 6. ARS of soil profile in CSP3-M

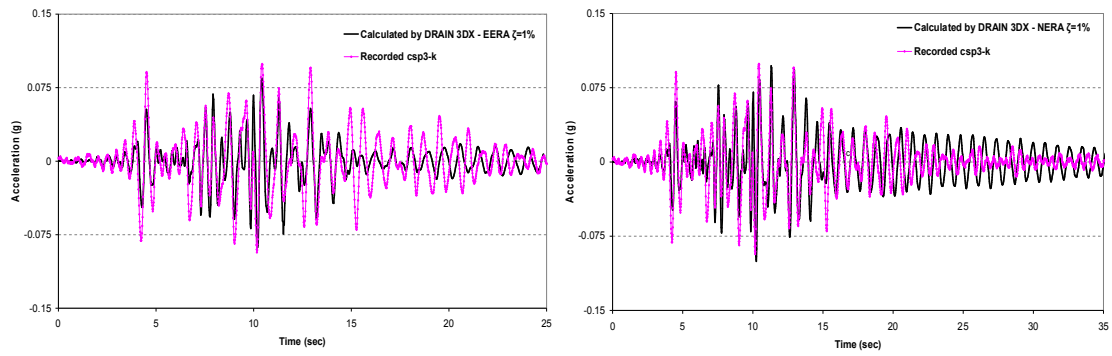

Figure 7. Super structure acceleration response CSP3-K ($\xi=1\%$)

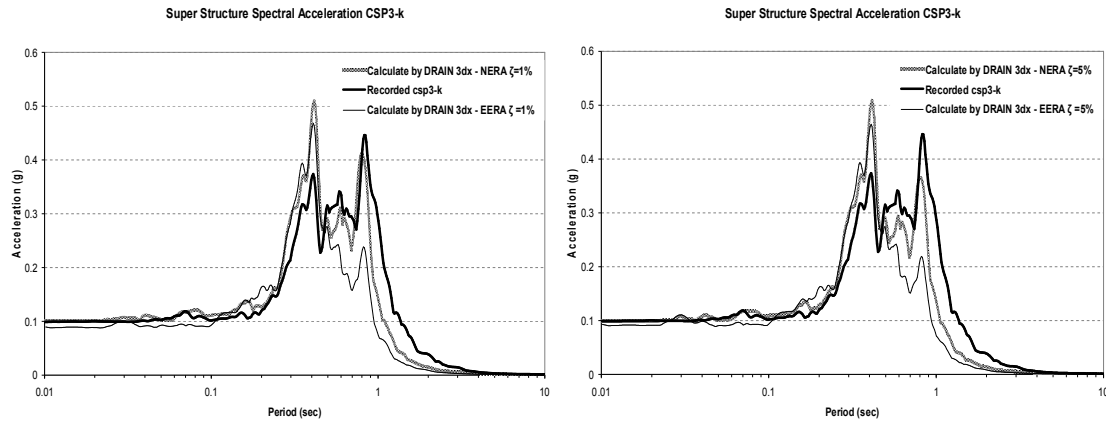

Figure 8. ARS of Superstructure CSP3-K

6.2. CSP5 Tests

In these tests, the soil profile consisted of two horizontal layers [24]. The lower layer was uniformly graded Nevada sand, 11.4 m thickness with the relative density of $Dr = 75-80\%$ (similar to CSP3). The upper layer was normally consolidated reconstituted Bay mud ($LL=88, PI=48$), 6.1 m thickness placed in four equal layers and each layer preconsolidated under an applied vertical stress. Filter paper was embedded between clay layers to accelerate consolidation. Water was used as pore fluid and saturation was verified with P-wave velocities measured from top to bottom of the soil profile near the container center. Values were high enough (approximately 1000 m/s) to indicate that sample was very close to the saturated state. The single pile (SP1) was aluminum and had a diameter of 0.667 m, 63 mm wall thickness and total length of 20.57 m, the superstructure mass was 49100 kg. In this study, CSP5-B and CSP5-D are analyzed with a BNWF system using Fiber Elements as it was

described earlier. Simulated earthquakes in this case are presented in table 2.

Calculated and recorded horizontal Acceleration Response Spectra (ARS) at different depths of soil (considering 5% of damping) for CSP5 shaking events are shown in Figures 9 and 10. Some deviations from experimental results are shown in ARS of soil in case CSP5-B which could contribute in discrepancies between responses of recorded and calculated superstructure of this case.

The ARS of super structure for CSP5-B and CSP5-D are plotted in Figures 11 and 12, respectively. It is observed from super structure ARS both in recorded and analyzed results that the equivalent fundamental period of the structural model varied from 1.3 S under event "B" to 1.4 S under event "D".

Calculated responses are in good agreement with the recorded centrifuge test responses, with limited number of exceptions. The combined effects of free field analysis response and simplicity in the model contribute to the discrepancies between recorded and calculated response in the models analyzed.

Table 2. Earthquake events for CSP5

Event	Motion	Peak Base Acceleration (g)
B	1989 Loma Prieta (Santa Cruz)	0.12
D	1989 Loma Prieta (Santa Cruz)	0.3

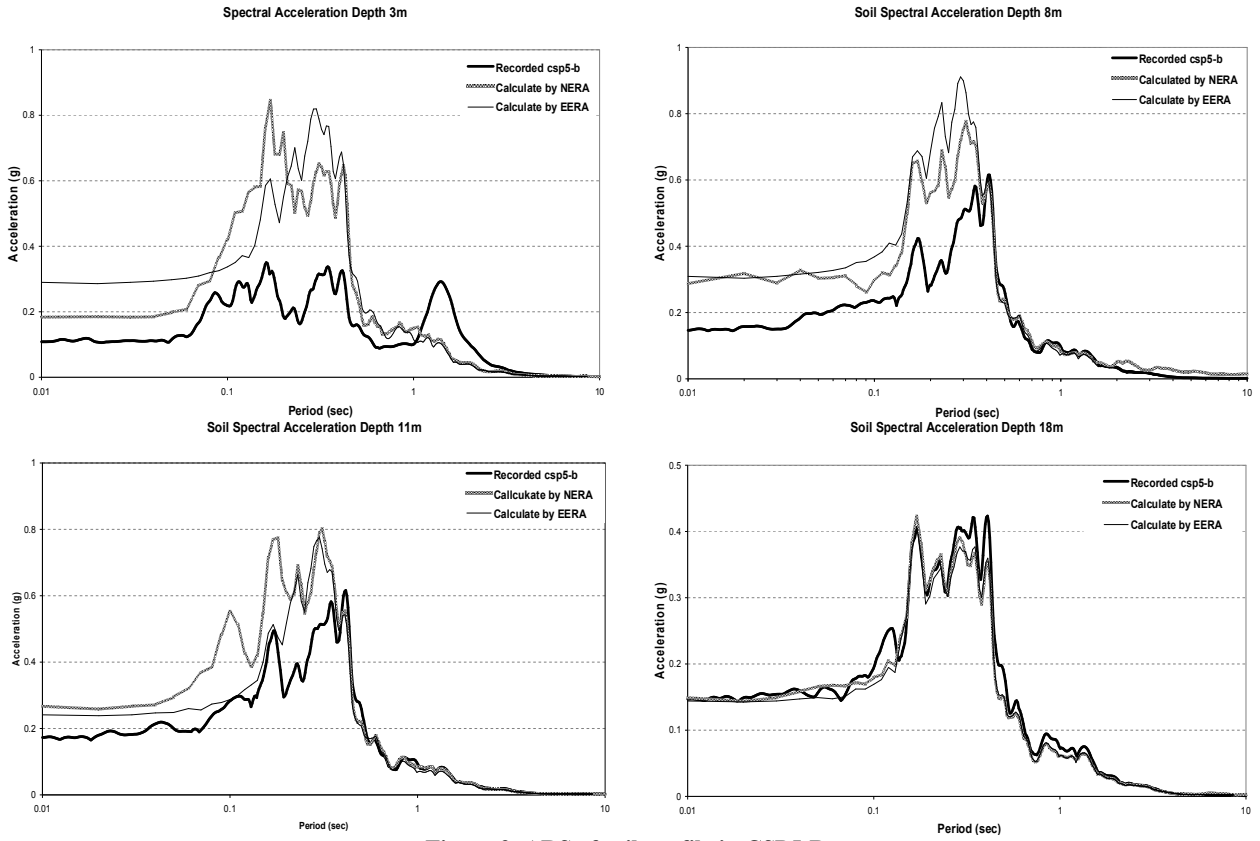

Figure 9. ARS of soil profile in CSP5-B

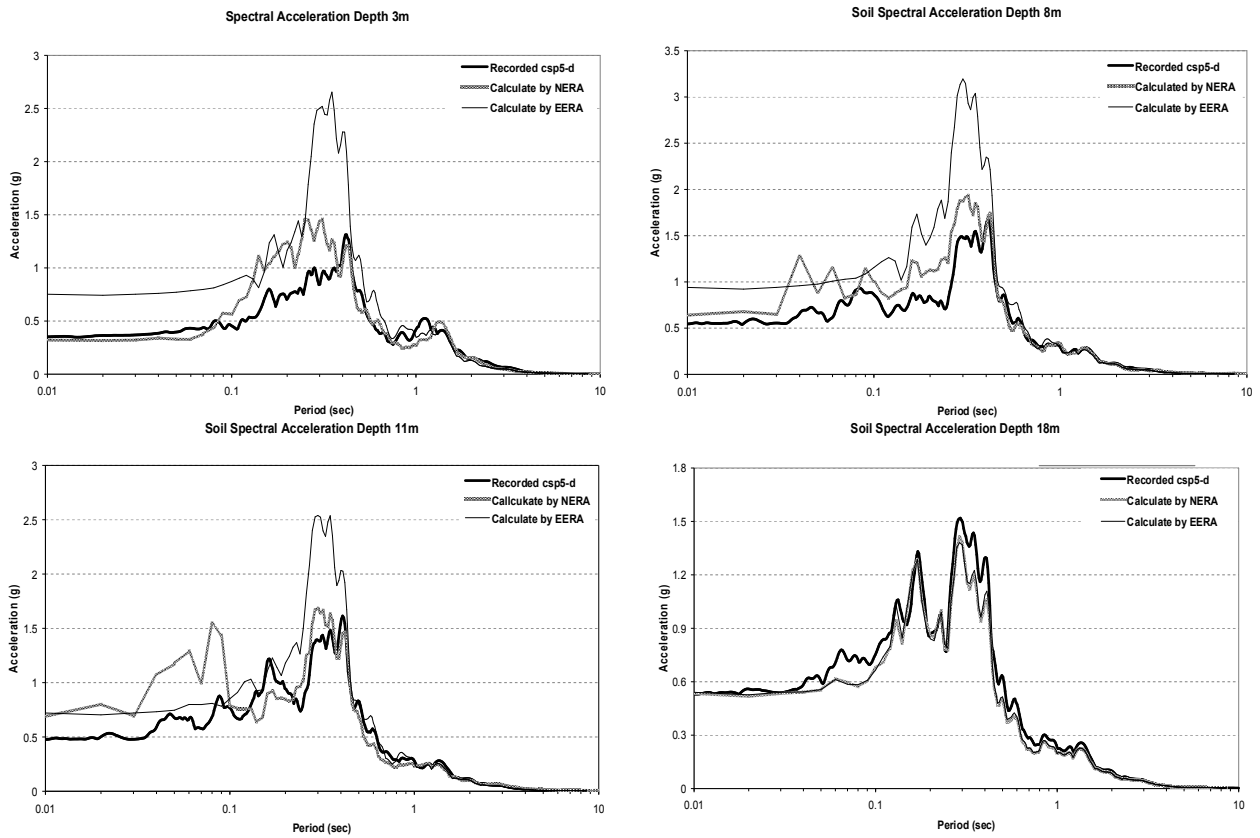

Figure 10. ARS of soil profile in CSP5-D

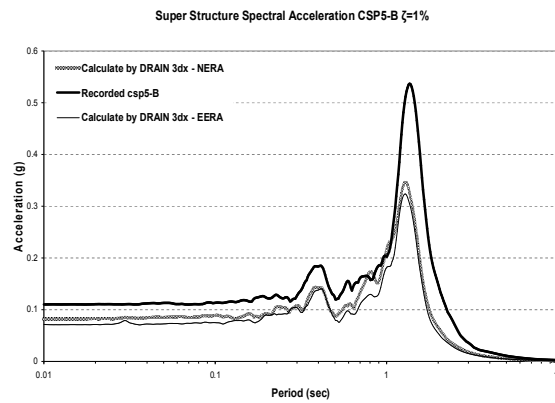

Figure 11. ARS of Superstructure in CSP5-B

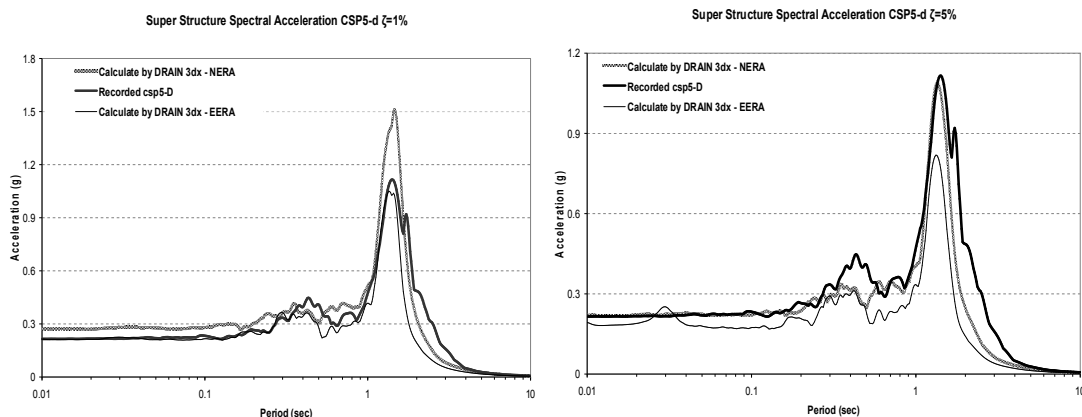

Figure 12. ARS of Superstructure in CSP5-D

7. Discussion

A very simple procedure for simulation of seismic soil-pile superstructure interaction has been proposed by this paper, which tries to utilize available elements and capabilities of Drain-3DX software instead of developing an individual and specific element for this purpose. Like any other contributions in the engineering field, the idea is very simple and has been inspired by what happens in reality. In real case of pile foundation, soil masses are available in both sides of pile and are in contact with the pile at rest. When the earthquake ground motion happens, the soil masses in both sides of the pile move identically to a specific direction. At this moment, while at first the pile is still in its location, the soil on one side pushes the pile whereas the soil on the opposite side loses its contact with pile and gets away from it. Herein, the proposed model tries to simulate this natural phenomenon by placing supporting beams in both sides of pile and exerting identical ground motion at the same time on both fixed ends of these beams. The compression link element provides a means that pile loses its contact when it is in tension relative to soil. In spite of being simple, the proposed model has the advantage of simulating the complex soil-pile interaction mechanism when the gaps opened. During the cyclic lateral loading, the gaps develop in cohesive soils. The inclusion of gaps changes the shape of compression and tension p-y curves from vertical S-shape to horizontal “~” shape. The compression link

element can take into account the opening of gaps and the change in shape of p against y curves. When the pile is moving within these gaps in subsequent cycles, the water inside the gaps exerts a drag force on the sides of the pile. This residual resistance is ignored in the current model. The ratio of the residual resistance to the ultimate resistance P_{ult} is assumed to be 0.1-0.3 for clay according to back-calculated p-y curves from these centrifuge experiments (Wilson et al. [21]). The ignorance of this residual resistance is believed to have a slight influence on dynamic pile response.

The results of previous back-calculated p-y behavior for liquefying sand from laboratory tests and FEM analysis (Wilson et al. [25]), generally showed that p-y characteristic is consistent with the known stress strain response of liquefying sand. This means that the typical cyclic p-y curve has a contraction phase, phase transformation part, which leads to large permanent deformations and a hardening part which is due to the dilation tendency of cohesionless soils (cyclic mobility). The occurrence of large permanent deformations in the phase transformation part of response is identical to opening of gaps and can be simulated by compression link element. This is similar to inverted S-shaped p-y characteristics of cohesive soils. From the observed p-y curves (Wilson et al. [25]), the ratio of strength in contraction part to ultimate resistance of p-y spring seems to be 0.1 and can be neglected. While being rigorous in many aspects, the model has some shortcomings in

modeling radiation damping, which could pose some uncertainties in the predicted response. Herein, the viscous damping dashpot is placed in parallel with hysteretic nonlinear spring. The radiated energy from the pile is dissipated mostly in far-field soil where the behavior is dominantly linear elastic. Furthermore, the presented relationships in the literature for computation of radiation damping dashpot coefficient were derived based on theory of elasticity and the assumption of linear elastic models. Thus, relating the amount of damping to nonlinear elastic-plastic deformations in the near field is not reasonable and has been shown that could lead to dramatically large damping forces (Badoni and Makris [26]). This can be a part of sources of underestimation of response in some cases in this report. However, the precise effect of parallel radiation damping on response can be checked in a parametric study by eliminating damping dashpots or using alternative arrangement of dashpots by placing them in series with nonlinear springs. Another fact about losses of energy through radiation damping is that the stress waves radiated from the pile can't be transferred from opened gaps. Since the compression link elements are placed in series with nonlinear and dashpot elements, this phenomena is correctly modeled.

The developed model neglects cyclic degradation of p-y curves, and dependence on pore water pressure generation. The cyclic resistance of p-y springs at any instant in time for cohesionless soils depend on the corresponding free-field and near-field levels ($r_u = \Delta u / \sigma_v$, of 100%; Δu = excess pore pressure, σ_v = vertical effective overburden pressure). After triggering of liquefaction ($r_u=100\%$) the p-y springs lose their resistance capacity to a significant percent. To avoid this, in present paper those events have been chosen for comparison purposes that generated Excess pore pressures in the soil profile were generally small. It is believed that the reduction in p-y resistance doesn't occur in dense sands and, therefore, the proposed model would be able to predict reliable results in dense sands.

The dynamic response of JTOPs during seismic excitation is somewhat different in nature than those of onshore structures. In addition to mass of different components of structures, an extra mass is added to submerged part of structure termed as "added mass" which, equals to mass of displaced volume of water. This extra amount of added mass should be computed manually and added to existing mass of components. The hydrodynamic damping is another issue regarding to the dynamic response of JTOPs. It's a common practice in analyzing the dynamic response of JTOPs to consider 5% amount of critical viscous damping for taking into account both the material and hydrodynamic damping [2]. The mass proportional term of Rayleigh damping could be utilized for this

5% amount of hydrodynamic damping. Note that the mass proportional dampers, in effect, treat the structure as though it were submerged in a viscous fluid. The drag in this fluid produces reactions external to the structure [27]. The static buoyancy forces can be taken into account by subtracting buoyancy forces from gravity loads during the gravity analysis of response. It is believed that the buoyancy forces don't change significantly during dynamic response phase.

It should be noted that element "Fiber Beam Column Post Buckling Element" can not take into account the deformation and collapse of a pile with pipe section subjected to internal or external pressure, nor is it capable of considering the local buckling effects. However, this may not be considered as a deficiency for the intended applications since in tubular members of offshore jackets, these phenomena are prevented by limiting the ratio of diameter to thickness [4],[5]. If any data is available about the strain at the onset of local buckling for a particular pile cross section and the ratio of diameter to thickness, then, it is explicitly possible to eliminate the fiber at this critical strain.

8. Conclusion

In this paper nonlinear behavior of soil-pile system subjected to earthquake ground motion has been studied using a fiber beam column element of DRAIN-3DX. In order to verify the developed computer model, a comparison is made with available experimental centrifuge tests. The agreements between the measured and calculated acceleration time histories and acceleration response spectra are reasonably good, indicating that proposed model does have the potential for capturing the dynamic response of piles.

This model may also be used for the nonlinear analysis of Jacket Type Offshore Platforms (JTOP) considering soil pile structure interaction. One of the biggest advantages of proposed method is making DRAIN-3DX software – in conjunction with other elements of DRAIN-3DX - capable of performing Seismic Soil-Pile-Superstructure Interaction (SSPSI) analysis of any pile supported structure specially JTOPs.

9. References

- 1- Aghakouchak, A. A. and Asgarian, B. (1996), *Dynamic Characteristics of a Jacket Type Offshore Platforms Considering Nonlinear Behavior of Pile Foundations*, OMAE Conference, Italy.
- 2- Recommended practice for planning, (2000), *designing and constructing fixed offshore platforms*, 21th Ed., API Recommended Pract. 2A-WSD (RP 2A-WSD), American Petroleum Institute.
- 3- Prakash, V., Powell, G.H. and Campbell, S. (1994), *DRAIN-3DX base program description and user guide*, version 1.10, Report No.UCB/SEMM-94/07,

Department of Civil Engineering, University of California, Berkeley.

4- Asgarian, B., Aghakouchak, A. A. and Bea, R. G. (2005), *Inelastic Postbuckling and Cyclic Behavior of Tubular Braces*, ASME J. Offshore Mech. Arct. Eng., 127, p. 256–262.

5- Asgarian, B., Aghakouchack, A. A. and Bea R. G. (2006), *Non-linear analysis of jacket type offshore platforms using fiber elements*, ASME Journal of Offshore Mechanics and Arctic Engineering, 128, p. 224–32.

6- Asgarian, B. and Lesani, M. (2009), *Pile–soil-structure interaction in pushover analysis of jacket offshore platforms using fiber elements*, Journal of Constructional Steel Research., 65, p. 209-218.

7- Asgarian, B., Boroumand, M. and Soltani, R. H. (2006), *Nonlinear Dynamic Analysis Of Pile Foundation Embeded In Sand Subjected To Strong Ground Motion Using Fiber Elements*, 25th International Conf. on Offshore Mech. and Arctic Eng., OMAE2006-92489.

8- Reese, L., Cox, W. and Koop, F. (1975), *Field testing and analysis of laterally loaded piles in stiff clay*, Proc. 7th Offshore Technology Conf., OTC 2312, Houston, 2, p. 671-690.

9- Berger, E., Mahin, S. A. and Pyke, R. (1977), *Simplified method for evaluating soil–pile–structure interaction effects*, proceeding of 9th offshore Technology Conference, OTC, paper 2954, Huston, Texas, p. 589 – 598.

10- El Naggar, M.H. and Bentley, K.j. (2000), *Dynamic analysis for loaded piles and dynamic p-y curves*, Canadian Geotechnical Journal, 37, p.1166-1183.

11- Matlock, H. (1970), *Correlations for design of laterally loaded piles in soft clay*, Proc., 2nd Annual Offshore Technol. Conference, Houston, Texas.

12- O’Neill, M. and Murchison, J. (1983), *An Evaluation of P-Y Relationships in Sands*, Rpt. GT-DF02-83, Dept. of Civil Eng., Univ. of Houston, May.

13- Bea, R. (1990), *Dynamic Loading Effects on Pile Capacity*, in H.B. Seed Memorial Symposium, Vol. 2, BiTech, 377-412.

14- WoLF, John P. (1985), *Dynamic soil-structure interaction. Prentice-Hall international series in civil eng. and eng. mechanics*, ISBN 0-13-221565-9.

15- Bardet, J.P. and Tobita, T. (2000), *EERA: a computer program for Equivalent-linear Earthquake site Response Analyses of Layered Soil Deposits*, Department of Civil Engineering, University of Southern California, Los., Cal.

16- Bardet, J. P. and Tobita, T. (2001), *NERA: a computer program for Nonlinear Earthquake site Response Analysis of Layered Soil Deposits*, Department of Civil Engineering, University of Southern California, Los., Cal.

17- Wang, S., Kutter, B. L., Chacko, J. M., Wilson, D. W., Boulanger, R. W. and Abghari, A. (1998), *Nonlinear seismic soil-pile-structure interaction*, Earthquake Spectra, 14(2), p. 377–396.

18- Iwan, W.D. (1976), *On a class of models for the yielding behavior of continues and composite systems*, Journal of Applied Mechanics, ASME, 34, p. 612 – 617.

19- Morze, Z. (1967), *On the description of anisotropic work hardening*, Journal of Mechanics and physics of solids, 15, p. 163 – 175.

20- Powell, G. H. and S. Campbell, (1994), *Drain – 3DX Element Description and User Guide for Element Type 15*.

21- Wilson, D. (1998), *Soil – Pile – Superstructure Interaction In Liquefying Sand and Soft Clay*, Ph. D Dissertation. Report No. UCD/CGMDR-98/04, Ctr. For Geotechnical Modeling, Dep. of Civil and Environmental Eng., Uni. of California, Davis, CA.

22- University of California at Davis website: <http://nees.ucdavis.edu>.

23- Wilson, D. W., Boulanger, R. W. and Kutter, B. L. (1997a), *Soil-pile superstructure interaction at soft or liquefiable soil sites—Centrifuge data report for Csp3*, Rep. No. UCD/CGMDR-97/04, Ctr. for Geotech. Modeling, Dept. of Civ. and Envir. Engrg., University of California, Davis, Calif.

24- Wilson, D. W., Boulanger, R. W. and Kutter, B. L. (1997b), *Soil-pile superstructure interaction at soft or liquefiable soil sites—Centrifuge data report for Csp5*, Rep. No. UCD/CGMDR-97/06, Ctr. for Geotech. Modeling, Dept. of Civ. and Envir. Engrg., University of California, Davis, Calif.

25- Wilson, D. W., Boulanger, R.W. and Kutter, B.L. (2000), *Observed Seismic Lateral Resistance Of Liquefying Sand*, Jour. of Geotechnical and Geoenvironmental Eng., ASCE, 126(10), p. 898-906.

26- Badoni, D. and Makris, N. (1996), *Nonlinear response of single piles under lateral inertial and seismic loads*, Soil Dynamics and Earthquake Engineering, 15, p. 29-43.

27- Charney, F. (2008), *Unintended Consequences of Modeling Damping in Structures*, Journal Of Structural Engineering, ASCE, 134:4(584).